

Amphenol

SINE SYSTEMS

CONFIGURATION	PART NUMBER	LENGTH
TEE, 5 PIN, MINI	P29311	SEE BELOW

DIMENSIONS

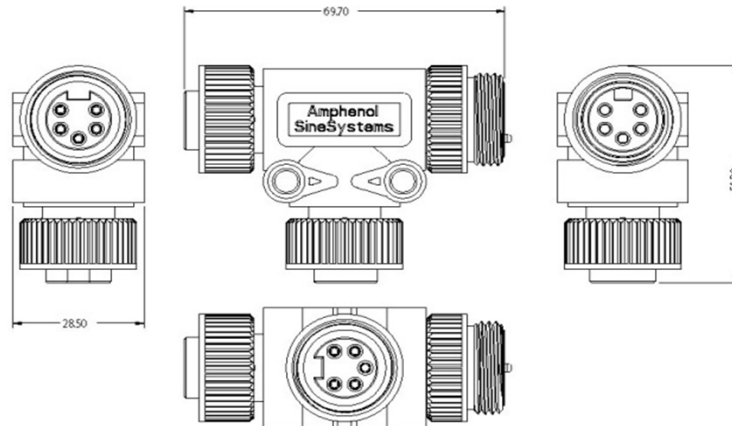

WIRING DIAGRAM

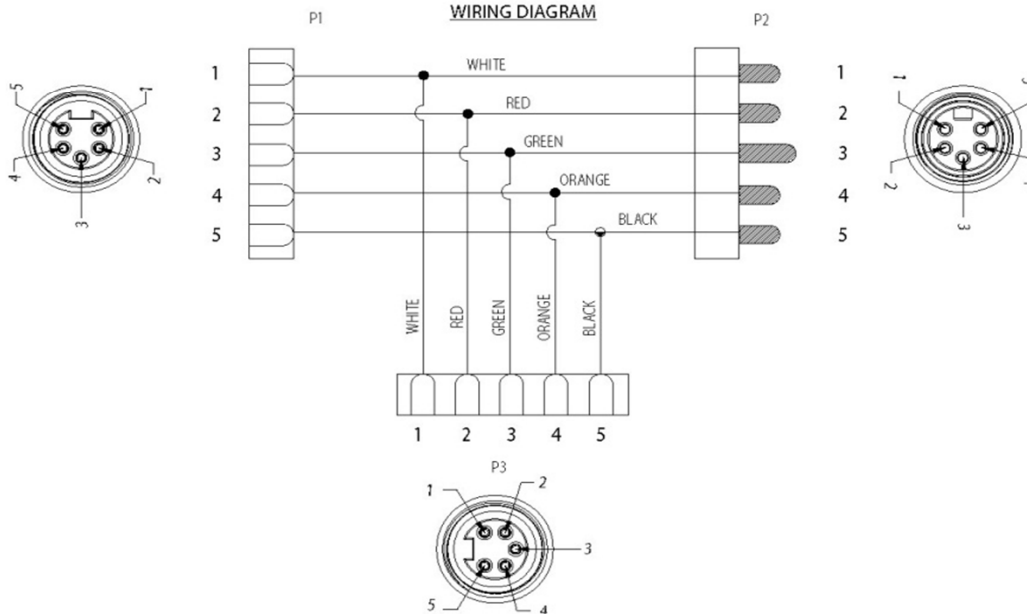

TECHNICAL DATA

APPROVALS:	UL, c(UL)
TEMPERATURE RANGE:	-20C to +105C
PROTECTION:	IP 67, NEMA 6P
VOLTAGE RATING:	600VAC
AMPERAGE:	8A
HOUSING:	OIL RESISTANT PVC
CONTACTS:	COPPER ALLOY
CONTACT PLATING:	GOLD OVER NICKEL PLATING
CONNECTOR FACE:	PVC
COUPLING:	MACHINED ALUMINUM, ANODIZED

Sales and Technical Support 1-800-394-7732

www.sineco.com

Amphenol
Sine Systems

© 2011 Amphenol Sine Systems Corporation. Every effort has been made to ensure that the information contained in this document is accurate at the time of publication. Specifications or information stated in this publication are subject to change without notice.